

# Year 7 Information 2021



*'I would like to acknowledge the Dja Dja Wurrung people, the Traditional Owners of the land on which we are gathered and pay my respect to their Elders both past and present.'*



MARYBOROUGH  
EDUCATION CENTRE

*Kindness, Aspiration & Respect*

# Outline

- **MEC Vision and Values**
- **Key Staff**
- **Year 7 Program**
- **Mentor Teachers**
- **Student Support**
- **BYOSD**
- **Key Dates**



David Sutton - Principal



MARYBOROUGH  
EDUCATION CENTRE

*Kindness, Aspiration & Respect*

# MEC Vision and Values

- **MEC Vision**  
To be an inclusive, connected and flourishing school

- **MEC Values**

Aspiration

Kindness

Respect



MARYBOROUGH  
EDUCATION CENTRE

*Kindness, Aspiration & Respect*

# Key Staff



**David Sutton**  
Principal



**Toni Briody**  
Transition Coordinator  
2020 Yr 7 Coordinator



**Ben Brady**  
Sub School Leader (7-10)



**Katherine King**  
Assistant Principal (7-12)



**Bethany Fitzpatrick**  
Assistant Transition  
Coordinator



**Angus McPherson**  
STEM Learning Specialist  
BYOSD Support



**Julie Reiger**  
Assistant Principal  
(Specialist)



MARYBOROUGH  
EDUCATION CENTRE

*Kindness, Aspiration & Respect*



# Example Year 7 Timetable

	MON	TUES	WED	THUR	FRI
9:00 - 10:00	Maths	English	Art	ICT/Indonesian	Technology
10:00 - 11:00			Humanities		Science
Recess - 11:00am-11:40am					
11:40 - 12:25	Physical Education	Science	Maths	Art	English
12:25 - 1:10					
Lunch - 1:10pm-1:45pm					
1:45 - 2:30	Technology	Humanities	English	Maths	Health
2:30 - 3:15					



# Maths - Six periods a week

I really enjoy math because I love the quick math we do at the start of each lesson.

I also like it because our teacher understands when we don't know about something and when we do understand.

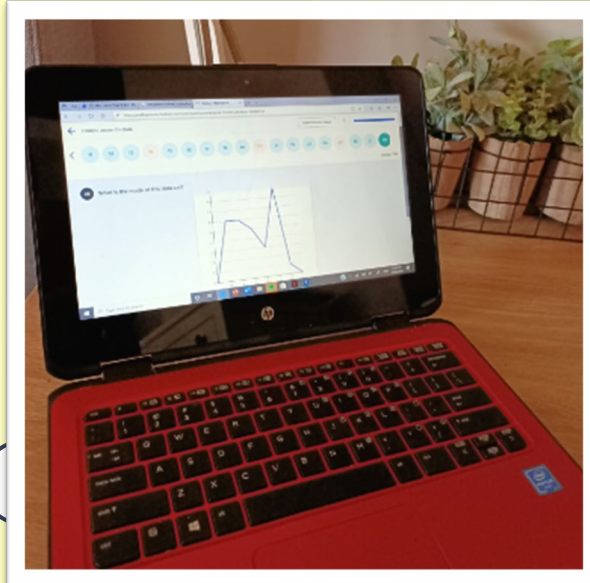

It's more challenging than in primary school so I have to actually think about what the answer's going to be.

Math this year has been fantastic so far, I have learnt things that I didn't learn in primary school and I have enjoyed it more than I thought I would have.

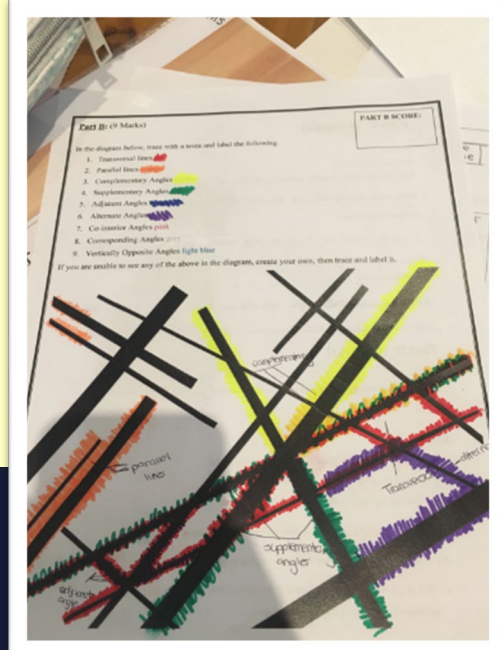
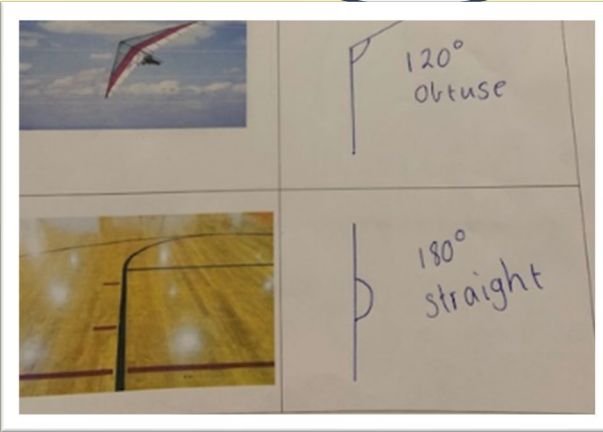

MARYBOROUGH EDUCATION CENTRE

Kindness, Aspiration & Respect



# English

- Six sessions a week
- Reading conferences to develop individual skills
- Yr 7 Autobiography Night



I absolutely loved studying the class text, Crow Country. Not only did I discover a book I would never read myself, but the discussions we had were really empowering about big issues.

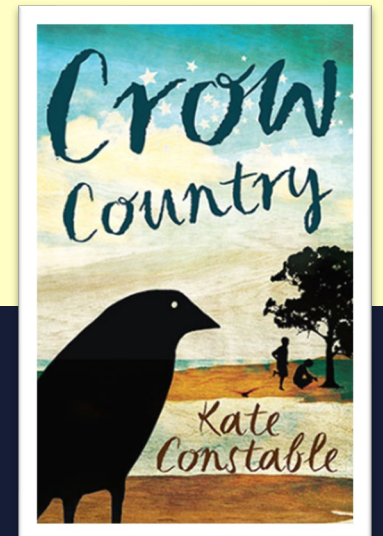



# Humanities

- Three periods a week
- Ancient Olympics Incursion



It's great how what we learn in Humanities pops up in other subjects all the time, like in English, and so you can see how everything works together.



Year 7 Humanities is great fun, I like the different ways we can present our projects so that we use our interests as well.



MARYBOROUGH  
EDUCATION CENTRE

*Kindness, Aspiration & Respect*



# Science

- Three periods a week

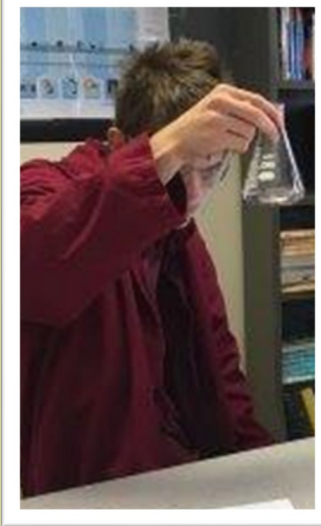
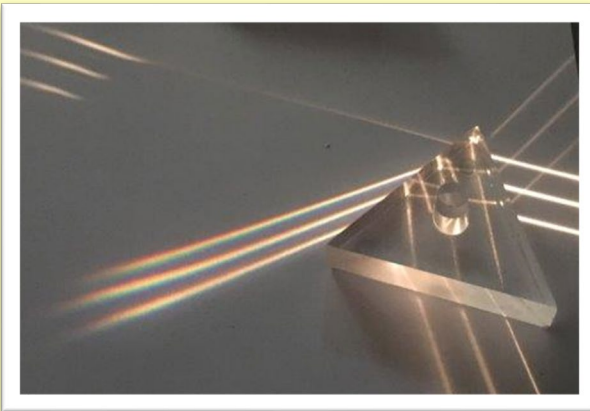

I like science because its engaging we learn about interesting things such as seasons, what causes day and night. Last term we learnt about solutions and we got to test a few drinks to see if they were a solution. We get to do some fun experiments, that's why I find science really interesting.

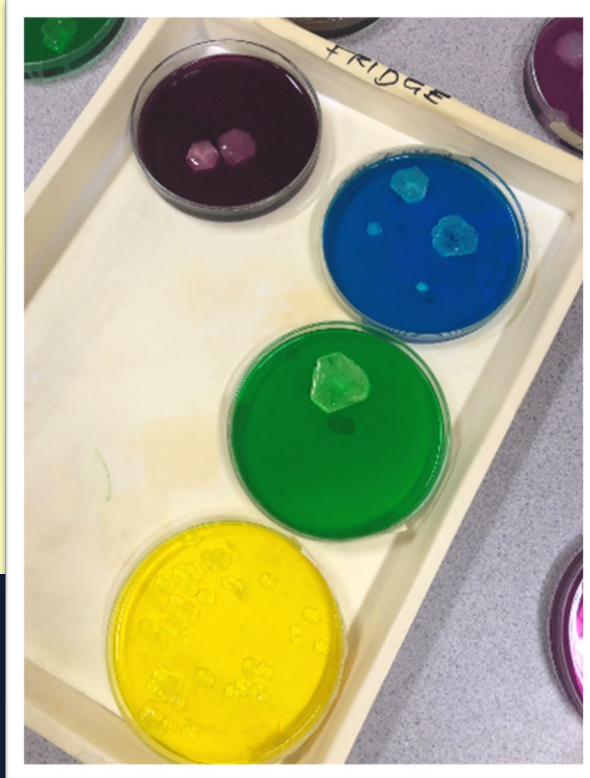

MARYBOROUGH  
EDUCATION CENTRE

*Kindness, Aspiration & Respect*



# Health & Physical Education

- A double period of Health and a double period of Physical Education each week
- Range of facilities including gymnasium, basketball courts, oval with athletics track
- Survival Swimming Day



We do lots of different sports and learn how to do things the right way without injuring ourselves, we play lots of team involved games and have lots of fun while doing it!



MARYBOROUGH  
EDUCATION CENTRE

*Kindness, Aspiration & Respect*



# Art

- Three periods a week
- Prep-12 Art Expo

In Art we do projects but before that we research, make drafts, annotations, appropriations and you learn the why the artist did this and that. You learn about different artworks.



MARYBOROUGH  
 EDUCATION CENTRE

Kindness, Aspiration & Respect



# Indonesian

- A double period for one semester.



It is an exciting new challenge that I have never experienced before, and it interests me to learn about a different culture.



Indonesian challenges me and my perspectives, I think about others and how their culture influences them in ways I wouldn't have without studying Indonesian.



MARYBOROUGH  
EDUCATION CENTRE

*Kindness, Aspiration & Respect*



# ICT

- A double period for one semester

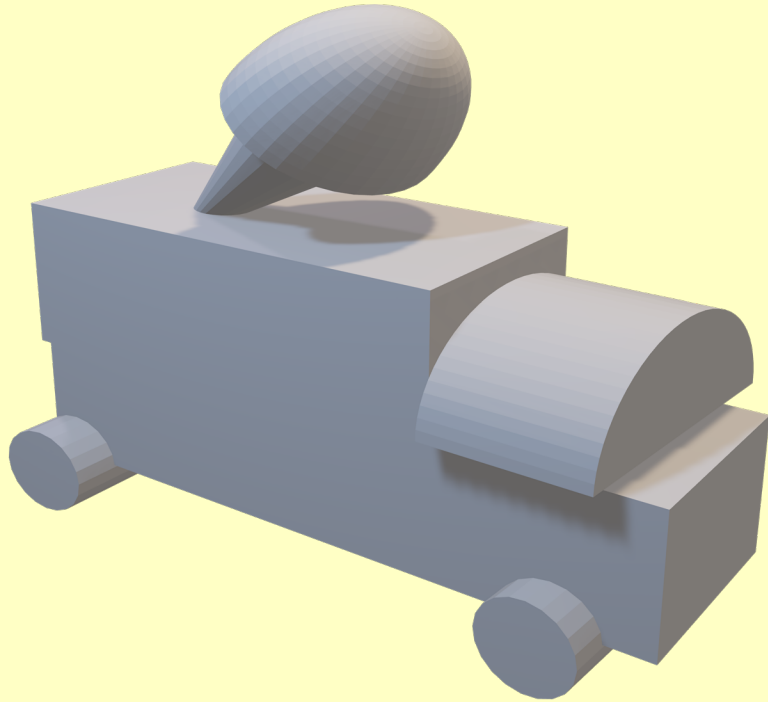

I love ICT, we are exposed to many different apps and how to use them. Using computers has never been so easy and actually even fun!

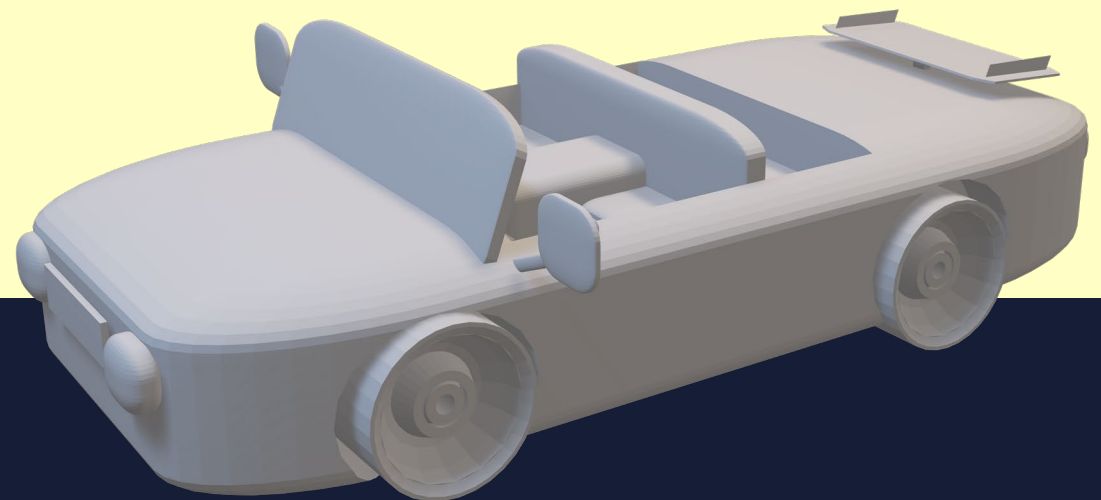

MARYBOROUGH  
EDUCATION CENTRE

*Kindness, Aspiration & Respect*



# Technology Rotations

Three periods a week, rotate after 8 weeks:

- Food Technology
- Textiles
- Woodwork
- Metalwork
- Media

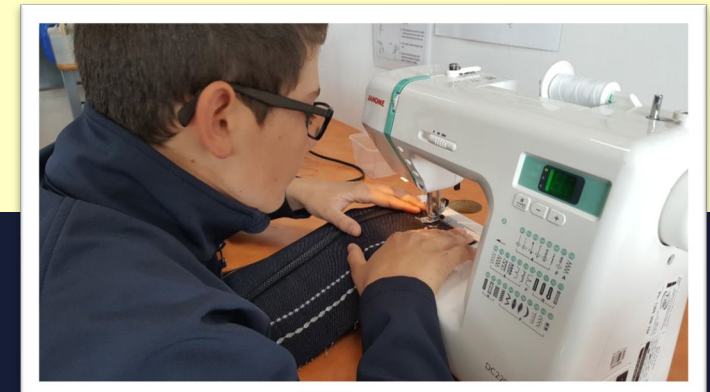
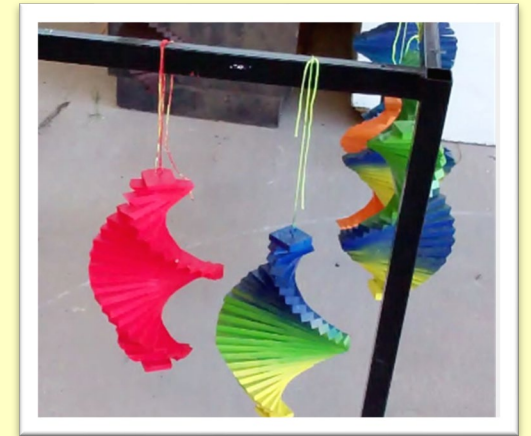
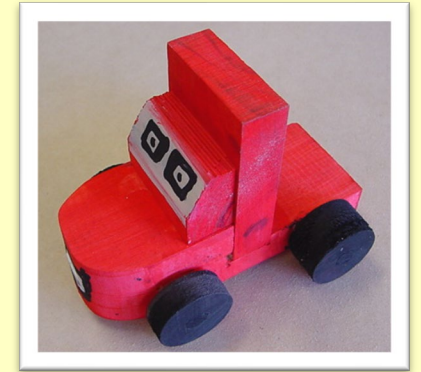

MARYBOROUGH  
EDUCATION CENTRE

*Kindness, Aspiration & Respect*



# Extra Curricular Activities

Instrumental lessons

School Band

Yr 7-12 Production

Energy Breakthrough

Swimming, Cross Country and Athletics Carnivals

A range of sports contested in the district, regional, state levels





# School Map

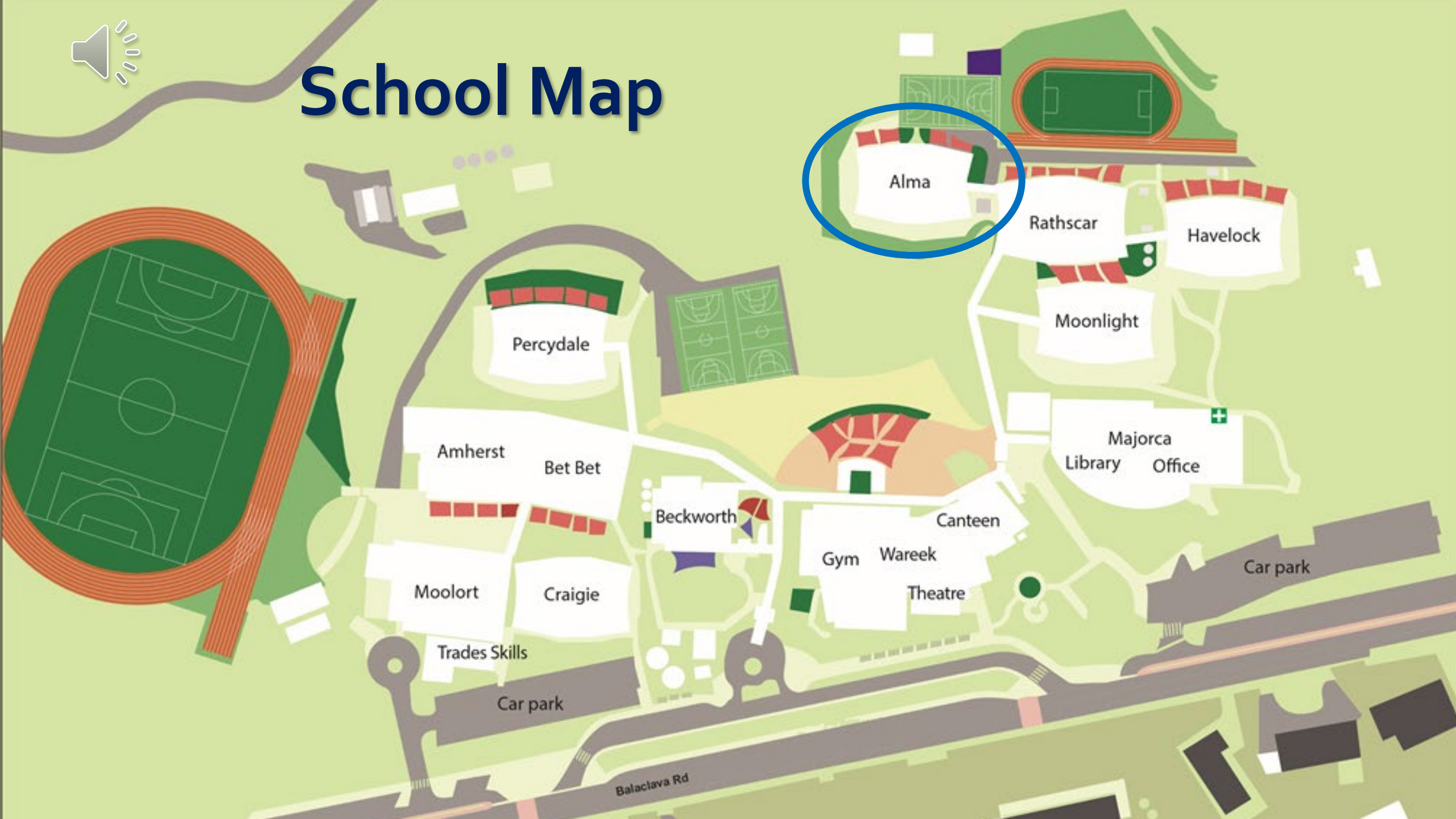

Alma

Rathscar

Havelock

Percydale

Moonlight

Amherst

Bet Bet

Majorca  
Library Office

Beckworth

Canteen

Car park

Moolort

Craigie

Gym Wareek

Theatre

Trades Skills

Car park

Balaclava Rd



# Finding your classroom

- Year 7 students have most of their classes in the Alma pod:
  - English
  - Maths
  - Humanities
  - Health
  - Media
  - ICT
  - Indonesian
- Initially teachers will collect and return the class to Alma when they need to move to different areas of the school:
  - Technology – Moolort
  - Physical Education – Wareek
  - Art – Bet Bet
  - Science - Amhurst





# Breaks

- Year 7 students are free to move anywhere in the 7-12 area during breaks. Yard duty teachers are visible in all break areas.
- The Library or classrooms are open during breaks for student use.
- The Gymnasium is open during some breaks with a staff member supervising.
- Alma area is only for Years 7 & 8 students, to provide a comfortable place.



MARYBOROUGH  
EDUCATION CENTRE

*Kindness, Aspiration & Respect*



# Mentor Teachers

- Each class has dedicated mentor teacher or teachers.
- Mentor teacher/s are the first port of call for students and parents.
- The class has their mentor teacher for at least one subject.
- Mentor teachers also undergo the teaching of values programs with the students.

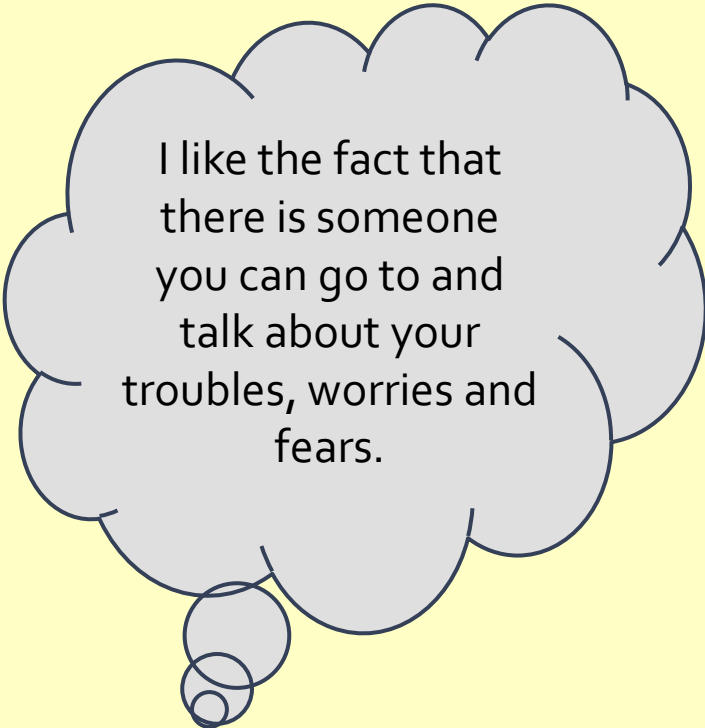

I like the fact that there is someone you can go to and talk about your troubles, worries and fears.

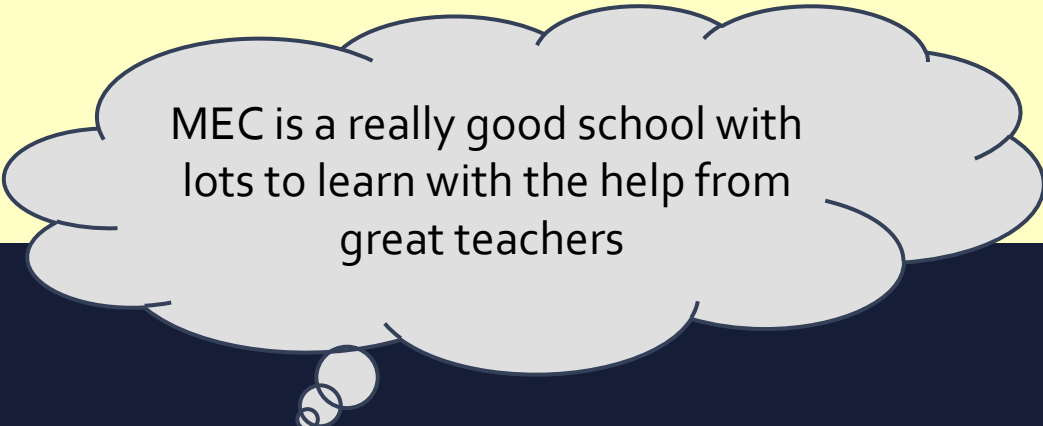

MEC is a really good school with lots to learn with the help from great teachers



MARYBOROUGH  
EDUCATION CENTRE

*Kindness, Aspiration & Respect*



# Student Support Services



**Elana Stoklahasa**  
Student Services Manager



**Catherine Poussard**  
Student Services Coordinator



**Jeannette Palmer**  
Family Liaison/Attendance Officer



MARYBOROUGH  
EDUCATION CENTRE

*Kindness, Aspiration & Respect*



# Learning Intervention and Enhancement Staff

- We understand that all students come to MEC at different levels. We have dedicated staff who can provide additional support to students with varying learning needs



**Fiona Etchell**  
Learning Enhancement  
Coordinator



**Josephine Harris**  
Literacy Intervention



MARYBOROUGH  
EDUCATION CENTRE

*Kindness, Aspiration & Respect*



# BYOSD – Bring Your Own Specified Device

You provide the device. We provide the software

Office 365 Subscription

Adobe Creative Cloud

STILE for Science

Clickview

Mathspace

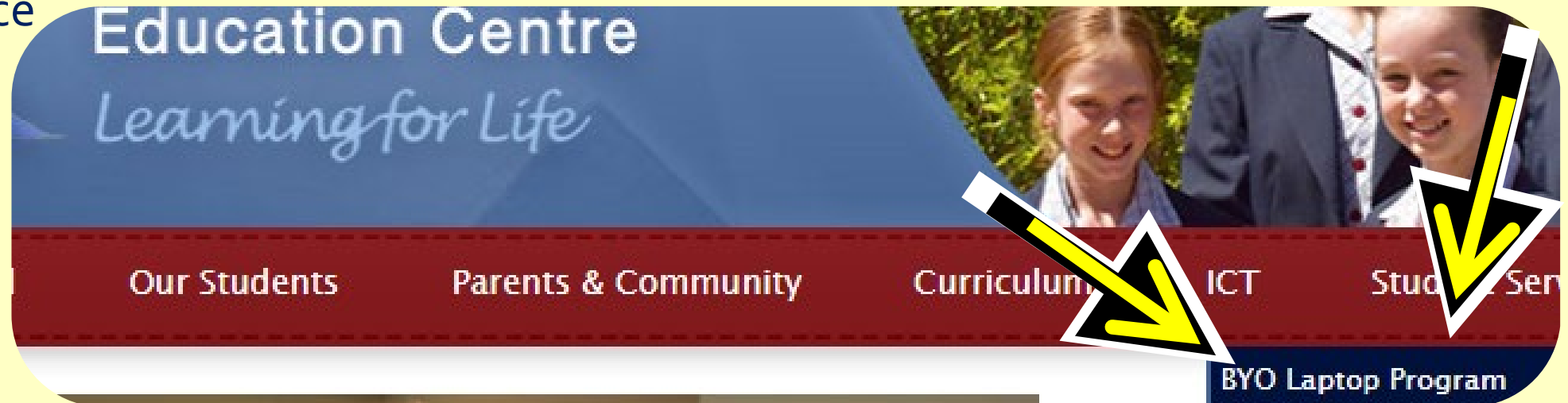

MARYBOROUGH  
EDUCATION CENTRE

*Kindness, Aspiration & Respect*

**LEARNING**  
with technologies



# Key Dates

## Term 2:

### Thursday 21st May ( released at 4:00pm - can be viewed at any time)

- MEC Year 7's 2021 Prospective Families Information Presentation
- Optional form to complete if you would like further information

### Friday 29th May

- 2021 Year 7 Preferred Placement Form Returned to Current Primary School



MARYBOROUGH  
EDUCATION CENTRE

*Kindness, Aspiration & Respect*



# Key Dates

## Term 3

Experience Sessions as have occurred in the past will be prioritised in Term 3 however are subject to the decisions outlined by the Department of Education as to when these can occur

Enrolment Information Evening - Will be confirmed at the beginning of Term 3

## Term 4

Ready , Set, MEC extra support transition sessions

**Tuesday 8th December** - State-wide Orientation Day



MARYBOROUGH  
EDUCATION CENTRE

*Kindness, Aspiration & Respect*

# Questions and Request for Further Contact

- If you would like further information click on the link below and we will ensure the most appropriate staff member contacts you.
  - **[Click Here to submit any questions](#)**
- We will start replying to your questions on Monday the 25<sup>th</sup> of May
- Alternatively, feel free to contact the school via phone or email
- School Email: **[maryborough.ec@education.vic.gov.au](mailto:maryborough.ec@education.vic.gov.au)**



MARYBOROUGH  
EDUCATION CENTRE

*Kindness, Aspiration & Respect*